

Air-cooled power capacitors Type 1

Type P \emptyset (225)

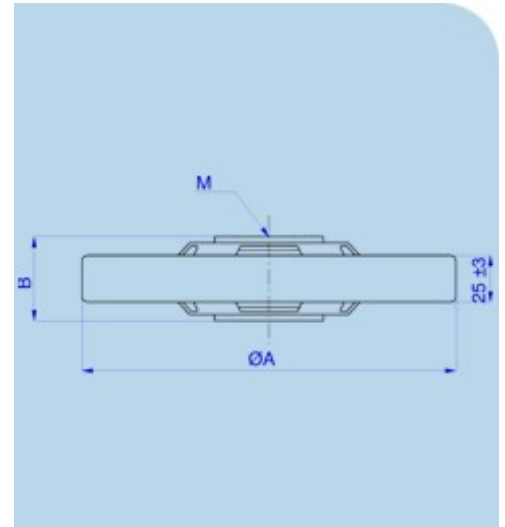

Plan

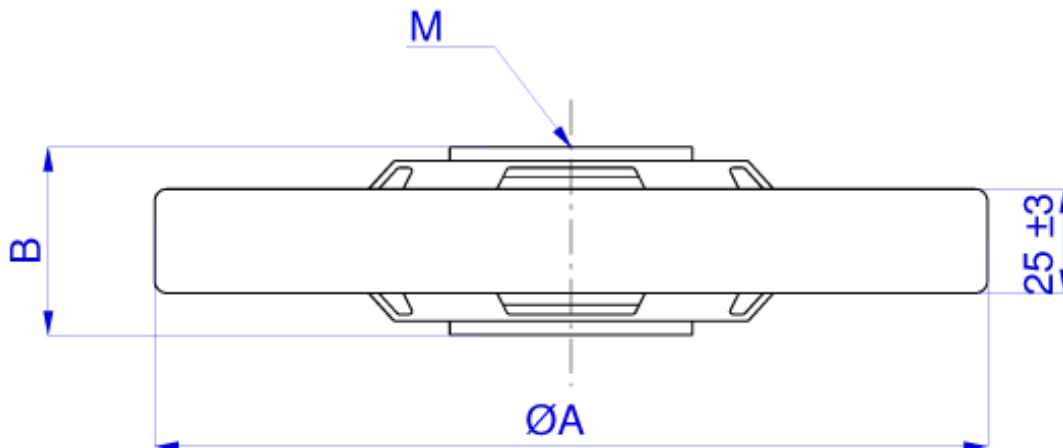

Characteristics

ELECTRICAL CHARACTERISTIC									DIMENSIONS			
References	Capacity pF ± 10%	ε r	Voltage		Frequencies		Nominal reactive power (kVar)	Nominal R.M.S intensity (A)	A (+0mm -25mm)	B (+3mm)	C (+2mm)	øM
			Un (kVc)	Utest (kVdc)	F1 (Mhz)	F2 (Mhz)						
40 621 815	400 pF	17	20	40	0,30	9,54	150 kVar	60 A	225	44	25	10
40 599 815	500 pF	17	20	40	0,24	7,63	150 kVar	60 A	225	44	25	10
40 746 815	600 pF	17	20	40	0,20	6,36	150 kVar	60 A	225	44	25	10
40 722 815	800 pF	17	20	40	0,15	4,77	150 kVar	60 A	225	44	25	10
40 587 815	1000 pF	17	20	40	0,12	3,82	150 kVar	60 A	225	44	25	10
40 723 815	1200 pF	17	20	40	0,10	3,18	150 kVar	60 A	225	44	25	10
40 589 815	1600 pF	75	20	40	0,07	2,39	150 kVar	60 A	225	44	25	10
40 600 815	2000 pF	75	20	40	0,06	1,91	150 kVar	60 A	225	44	25	10
40 596 815	2500 pF	75	20	40	0,05	1,53	150 kVar	60 A	225	44	25	10
40 576 815	3000 pF	75	20	40	0,04	1,27	150 kVar	60 A	225	44	25	10
40 718 815	4000 pF	75	18	36	0,04	0,95	150 kVar	60 A	190	44	25	10
40 574 815	5000 pF	75	18	36	0,03	0,76	150 kVar	60 A	225	44	25	10
40 575 815	6000 pF	75	17	34	0,03	0,64	150 kVar	60 A	225	44	25	10

Curves

40 621 815

400 pF

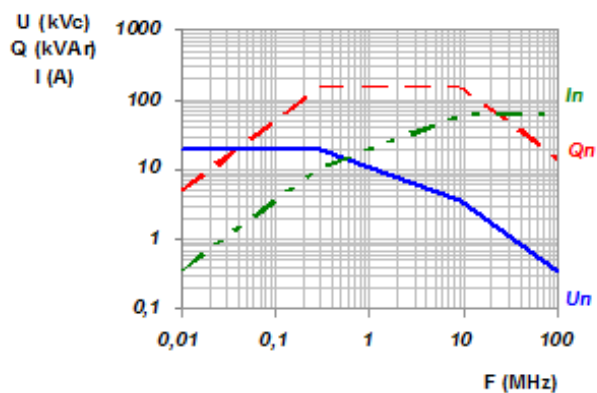

40 599 815

500 pF

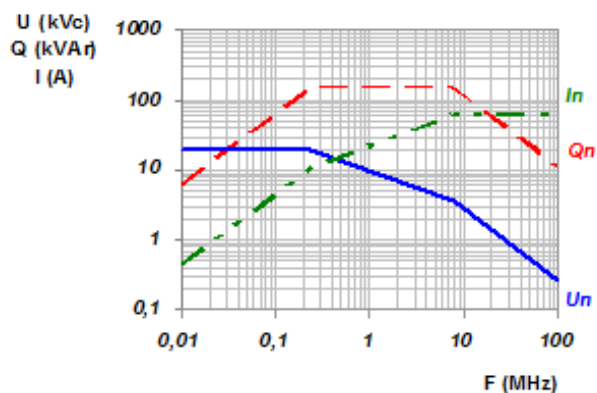

40 746 815

600 pF

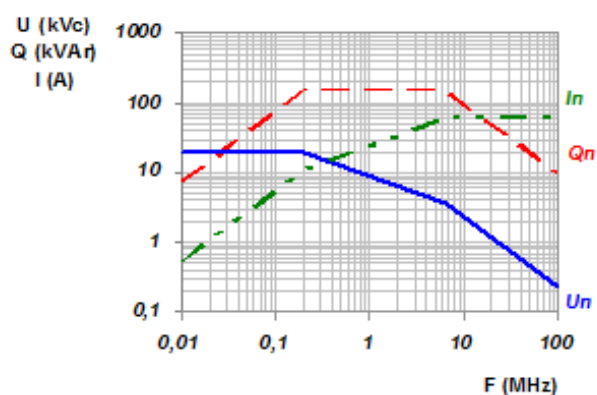

40 722 815

800 pF

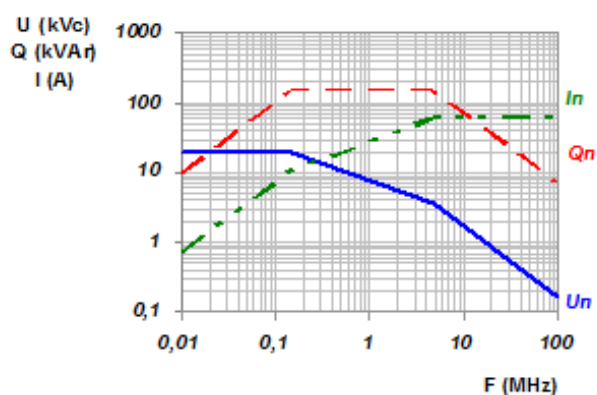

40 587 815

1000 pF

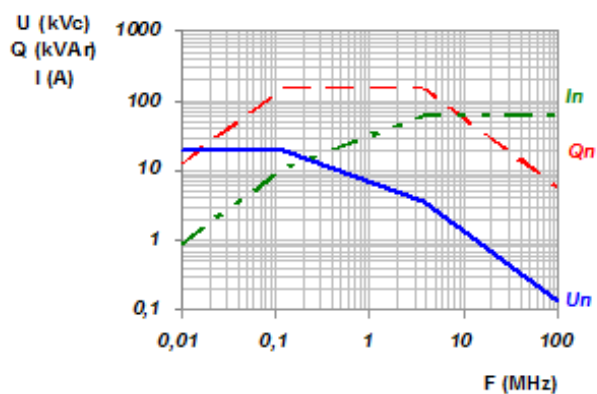

40 723 815

1200 pF

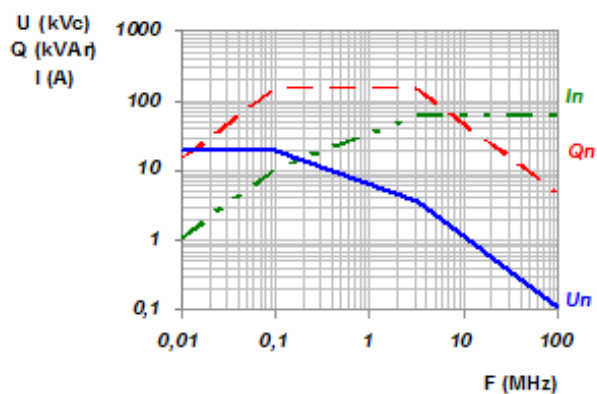

40 589 815

1600 pF

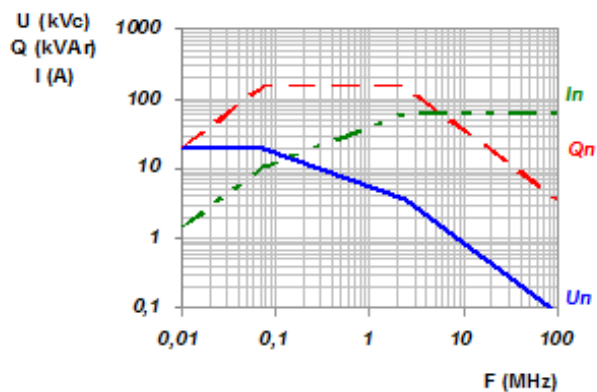

40 600 815

2000 pF

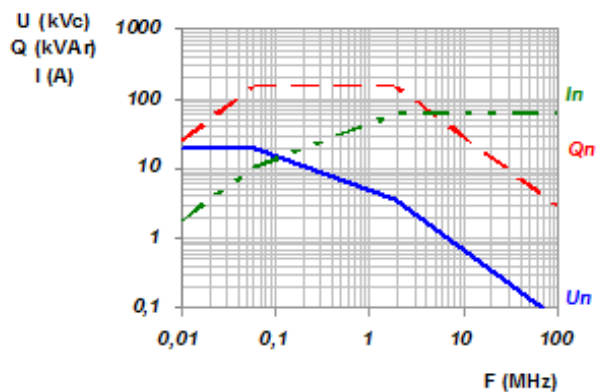

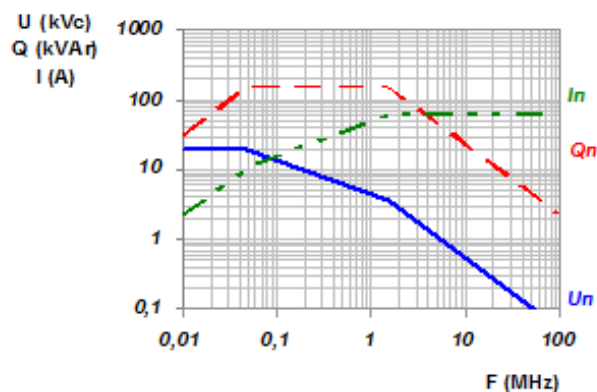
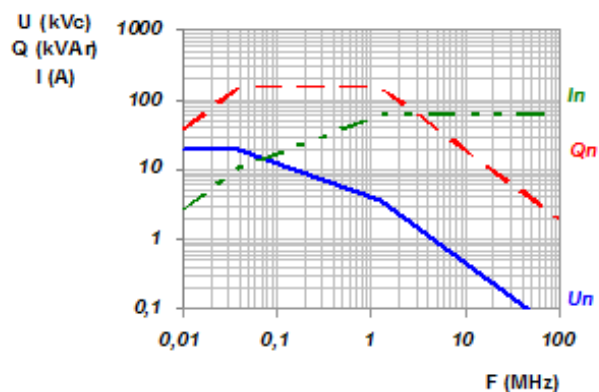
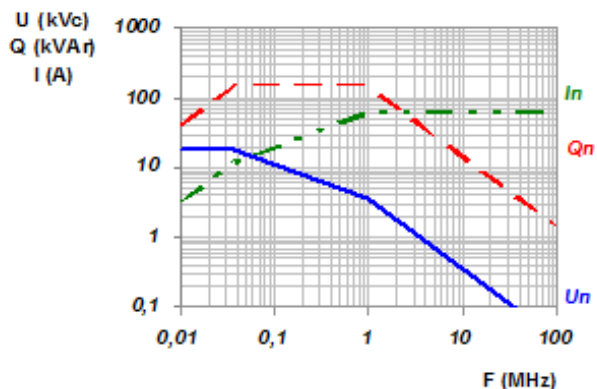
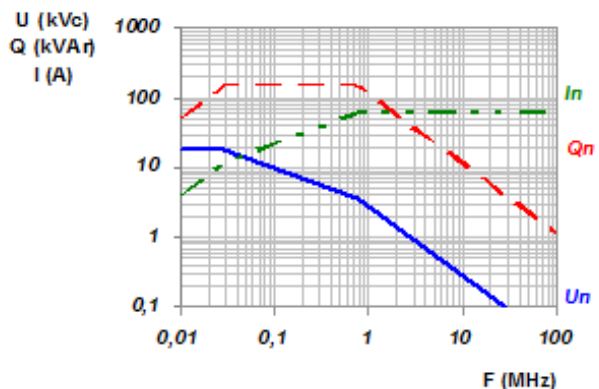
40 596 815**2500 pF****40 576 815****3000 pF****40 718 815****4000 pF****40 574 815****5000 pF****40 575 815****6000 pF**